

ASTRON WPN-A360

FIRST CONTINUOUS FEEDING SLICER EVER!

MORE PRODUCT EFFICIENCY.



NEW OPTION FOR YOUR FROZEN MEAT PROCESSING

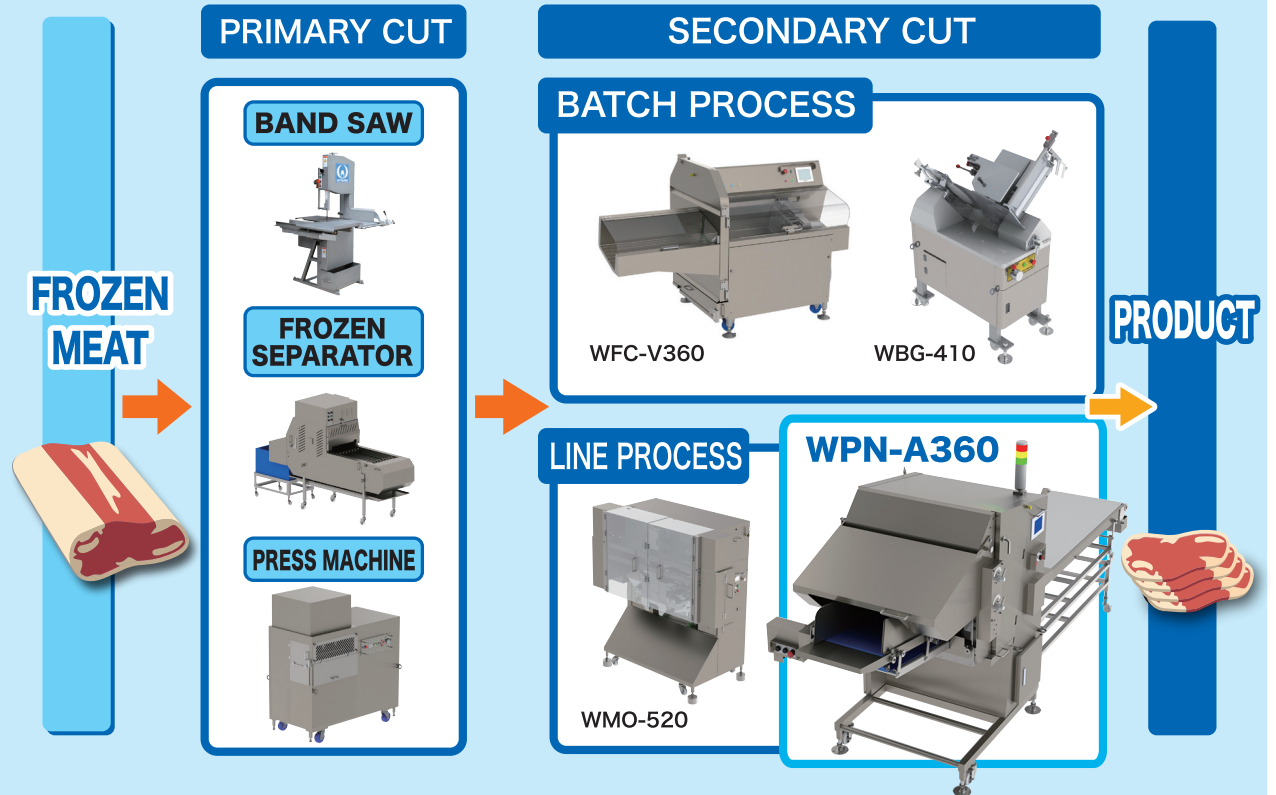

MORE PRODUCTION EFFICIENCY

Large sized infeed is newly designed.(W360mm×H200mm×L1,200mm)
It can feed two products at one time.
Max slice speed is 300slices/min

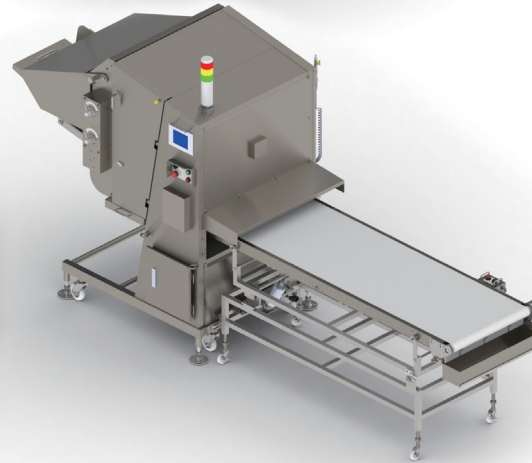
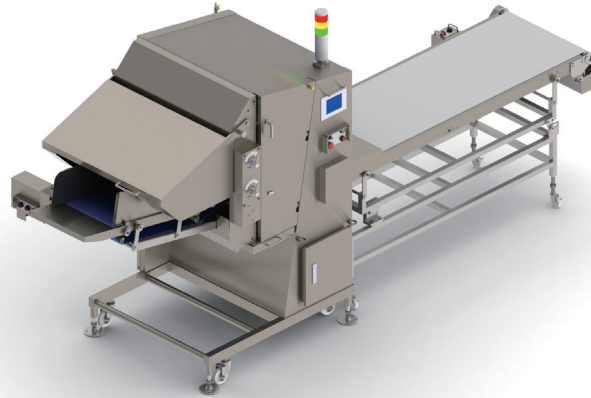
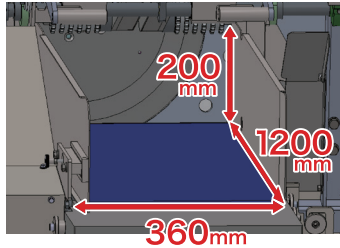

MORE QUALITY PROMISED

Upper feeding rollers grip the product tightly for the stable slicing.
More accurate thickness.

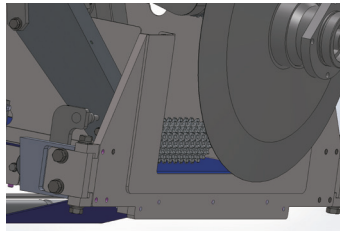

■ SPECIFICATION

DIMENSIONS	W3,765×D1,135×H1,670mm
MAX.SLICE SIZE	W360×H220×L1,200mm
SLICE THICKNESS	0.5~15mm
CAPACITY	50~300slices/min.
SLICE TEMPERATURE	-5~-2°C (Depends on the type of products.)
RATING ELECTRICITY	OUTPUT 2.08kW CURRENT 11.1A
POWER SUPPLY	3P 200V 50/60Hz MORE THAN 20A
COMPRESSOR	0.5MPa / 3 l / min

■ DRAWING

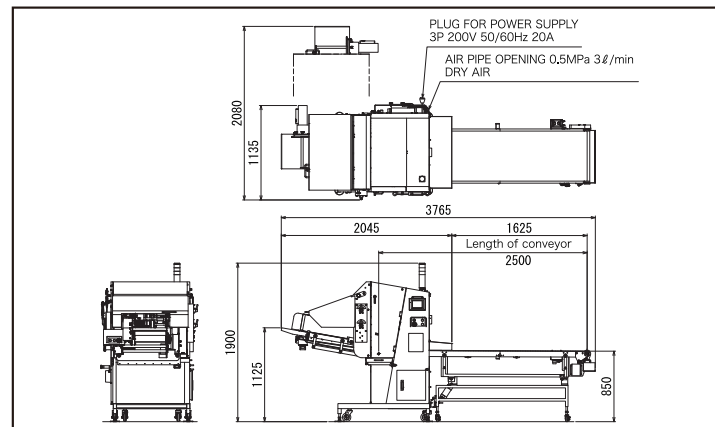

HIGIENE

Upper feeding rollers are able to disassemble.
Chain(drive part) never touches the product.
Machine, especially around the slicing position can be washed down.
Every part can disassemble. (About 30 minutes for cleaning up with 2 operators.)

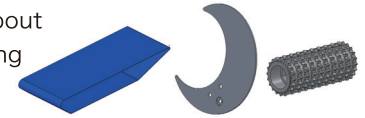
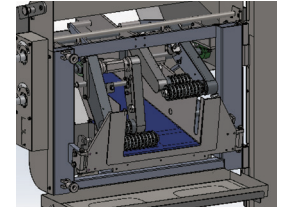

SAFETY

Interlock systems are used for all covers.
Reminders from the interlock system can be checked by a touch panel for your safety.

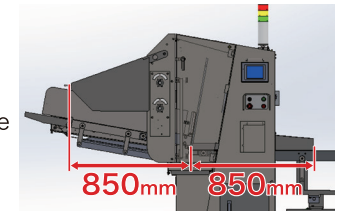

OPTION

- Meat Detecting Sensor Sensors tell you the timing to feed new materials on the inlet conveyor.
- Pneumatic auto gridding device

WATANABE
WATANABE FOODMACH CO.,LTD.

2-12-26 TSUYHASHI NAKAGAWA-KU NAGOYA JAPAN
TEL052-361-8511 FAX052-361-8490
URL: <http://www.foodmach.co.jp/>